

Features

- **HIGH-DENSITY PROGRAMMABLE LOGIC**
 - 8000 PLD Gates
 - 96 I/O Pins, 12 Dedicated Inputs, 2 Global Output Enables
 - 288 Registers
 - High-Speed Global Interconnect
 - Wide Input Gating for Fast Counters, State Machines, Address Decoders, etc.
 - Small Logic Block Size for Random Logic
 - Security Cell Prevents Unauthorized Copying
- **HIGH PERFORMANCE E²CMOS[®] TECHNOLOGY**
 - $f_{max} = 50$ MHz Maximum Operating Frequency
 - $t_{pd} = 22$ ns Propagation Delay
 - TTL Compatible Inputs and Outputs
 - Electrically Erasable and Reprogrammable
 - Non-Volatile E²CMOS Technology
 - 100% Tested at Time of Manufacture
- **IN-SYSTEM PROGRAMMABLE**
 - In-System Programmable[™] (ISP[™]) 5-Volt Only
 - Increased Manufacturing Yields, Reduced Time-to-Market, and Improved Product Quality
 - Reprogram Soldered Devices for Faster Debugging
- **COMBINES EASE OF USE AND THE FAST SYSTEM SPEED OF PLDs WITH THE DENSITY AND FLEXIBILITY OF FIELD PROGRAMMABLE GATE ARRAYS**
 - Complete Programmable Device Can Combine Glue Logic and Structured Designs
 - Four Dedicated Clock Input Pins
 - Synchronous and Asynchronous Clocks
 - Flexible Pin Placement
 - Optimized Global Routing Pool Provides Global Interconnectivity

Functional Block Diagram

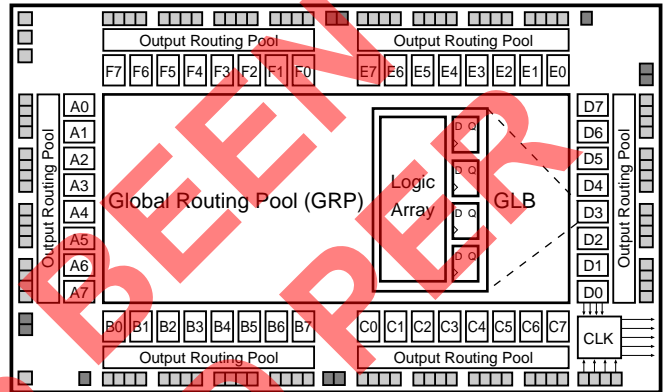

0139G1A-isp

Description

The ispLSI 1048C/883 is a High-Density Programmable Logic Device processed in full compliance to MIL-STD-883. This military grade device contains 288 Registers, 96 Universal I/O pins, 12 Dedicated Input pins, two Global Output Enables (GOE), four Dedicated Clock Input pins and a Global Routing Pool (GRP). The GRP provides complete interconnectivity between all of these elements. The ispLSI 1048C/883 features 5-Volt in-system programming and in-system diagnostic capabilities. It is the first device which offers non-volatile reprogrammability of the logic, and the interconnect to provide truly reconfigurable systems. Compared to the ispLSI 1048, the ispLSI 1048C/883 offers two additional dedicated inputs and two new Global Output Enable pins.

The basic unit of logic on the ispLSI 1048C/883 device is the Generic Logic Block (GLB). The GLBs are labeled A0, A1 .. F7 in figure 1. There are a total of 48 GLBs in the ispLSI 1048C/883 devices. Each GLB has 18 inputs, a programmable AND/OR/XOR array, and four outputs which can be configured to be either combinatorial or registered. Inputs to the GLB come from the GRP and dedicated inputs. All of the GLB outputs are brought back into the GRP so that they can be connected to the inputs of any other GLB on the device.

Copyright © 2002 Lattice Semiconductor Corp. All brand or product names are trademarks or registered trademarks of their respective holders. The specifications and information herein are subject to change without notice.

Functional Block Diagram

Figure 1. ispLSI 1048C/883 Functional Block Diagram

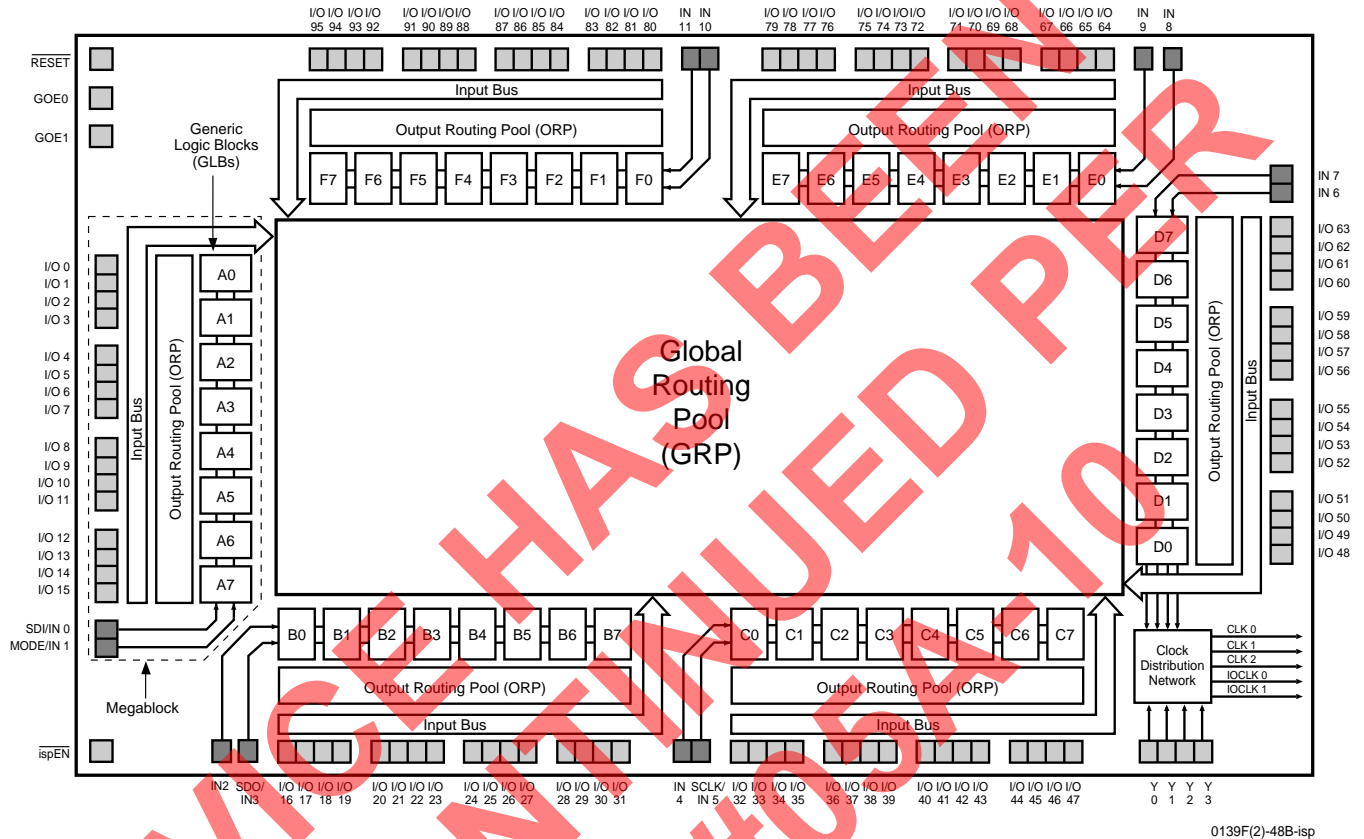

The device also has a 96 I/O cells, each of which is directly connected to an I/O pin. Each I/O cell can be individually programmed to be a combinatorial input, registered input, latched input, output or bi-directional I/O pin with 3-state control. Additionally, all outputs have selectable polarity, active high or active low. The signal voltage levels are TTL-compatible, and the output drivers can source 4 mA or sink 8 mA.

Eight GLBs, 16 I/O cells, two dedicated inputs and one ORP are connected together to make a Megablock as shown in figure 1. The outputs of the eight GLBs are connected to a set of 16 universal I/O cells by the ORP. Each ispLSI 1048C/883 device contains six Megablocks.

The GRP has, as its inputs, the outputs from all of the GLBs and all of the inputs from the bi-directional I/O cells. All of these signals are made available to the inputs of the GLBs. Delays through the GRP have been equalized to minimize timing skew.

Clocks in the ispLSI 1048C/883 device are selected using the Clock Distribution Network. Four dedicated clock pins (Y0, Y1, Y2 and Y3) are brought into the distribution network, and five clock outputs (CLK 0, CLK 1, CLK 2, IOCLK 0 and IOCLK 1) are provided to route clocks to the GLBs and I/O cells. The Clock Distribution Network can also be driven from a special clock GLB (D0 on the ispLSI 1048C/883 device). The logic of this GLB allows the user to create an internal clock from a combination of internal signals.

Absolute Maximum Ratings ¹

Supply Voltage V_{CC} -0.5 to +7.0V
 Input Voltage Applied -2.5 to $V_{CC} + 1.0V$
 Off-State Output Voltage Applied -2.5 to $V_{CC} + 1.0V$
 Storage Temperature -65 to 150°C
 Case Temp. with Power Applied -55 to 125°C
 Max. Junction Temp. (T_J) with Power Applied ... 150°C

1. Stresses above those listed under the “Absolute Maximum Ratings” may cause permanent damage to the device. Functional operation of the device at these or at any other conditions above those indicated in the operational sections of this specification is not implied (while programming, follow the programming specifications).

DC Recommended Operating Conditions

SYMBOL	PARAMETER	MIN.	MAX.	UNITS	
V_{CC}	Supply Voltage	Military/883 $T_C = -55^{\circ}C$ to $+125^{\circ}C$	4.5	5.5	
V_{IL}	Input Low Voltage		0	0.8	V
V_{IH}	Input High Voltage		2.0	$V_{CC} + 1$	V

0005A mil.eps

Capacitance ($T_A = 25^{\circ}C$, $f = 1.0$ MHz)

SYMBOL	PARAMETER	MAXIMUM ¹	UNITS	TEST CONDITIONS
C_1	Dedicated Input Capacitance	10	pf	$V_{CC} = 5.0V$, $V_{IN} = 2.0V$
C_2	I/O and Clock Capacitance	10	pf	$V_{CC} = 5.0V$, $V_{I/O}$, $V_Y = 2.0V$

1. Characterized but not 100% tested.

Table 2- 0006mil

Data Retention Specifications

PARAMETER	MINIMUM	MAXIMUM	UNITS
Data Retention	20	—	Years
Erase/Reprogram Cycles	10000	—	Cycles

Table 2- 0008B

Switching Test Conditions

Input Pulse Levels	GND to 3.0V
Input Rise and Fall Time	≤ 3ns 10% to 90%
Input Timing Reference Levels	1.5V
Output Timing Reference Levels	1.5V
Output Load	See figure 2

3-state levels are measured 0.5V from steady-state active level.

Table 2-0003

Output Load Conditions (see figure 2)

Test Condition	R1	R2	CL
A	470Ω	390Ω	35pF
B	Active High	∞	390Ω
	Active Low	470Ω	390Ω
C	Active High to Z at $V_{OH} - 0.5V$	∞	390Ω
	Active Low to Z at $V_{OL} + 0.5V$	470Ω	390Ω

Table 2-0004A

Figure 2. Test Load

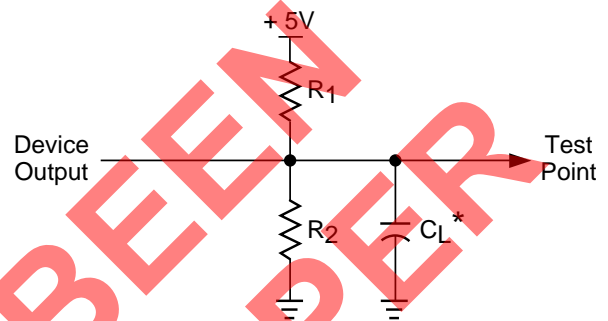

*CL includes Test Fixture and Probe Capacitance.

DC Electrical Characteristics

Over Recommended Operating Conditions

SYMBOL	PARAMETER	CONDITION	MIN.	TYP. ³	MAX.	UNITS
VOL	Output Low Voltage	$I_{OL} = 8 \text{ mA}$	–	–	0.4	V
VOH	Output High Voltage	$I_{OH} = -4 \text{ mA}$	2.4	–	–	V
IIL	Input or I/O Low Leakage Current	$0V \leq V_{IN} \leq V_{IL} \text{ (MAX.)}$	–	–	-10	μA
IiH	Input or I/O High Leakage Current	$3.5V \leq V_{IN} \leq V_{CC}$	–	–	10	μA
IIL-isp	isp Input Low Leakage Current	$0V \leq V_{IN} \leq V_{IL} \text{ (MAX.)}$	–	–	-150	μA
IIL-PU	I/O Active Pull-Up Current	$0V \leq V_{IN} \leq V_{IL}$	–	–	-150	μA
IOS¹	Output Short Circuit Current	$V_{CC} = 5V, V_{OUT} = 0.5V$	–	–	-200	mA
ICC^{2,4}	Operating Power Supply Current	$V_{IL} = 0.5V, V_{IH} = 3.0V$ $f_{TOGGLE} = 1 \text{ MHz}$	–	165	260	mA

1. One output at a time for a maximum duration of one second. $V_{out} = 0.5V$ was selected to avoid test problems by tester ground degradation. Characterized but not 100% tested.
2. Measured using twelve 16-bit counters.
3. Typical values are at $V_{CC} = 5V$ and $T_A = 25^\circ C$.
4. Maximum I_{CC} varies widely with specific device configuration and operating frequency. Refer to the Power Consumption section of this datasheet and Thermal Management section of the Lattice Semiconductor Data Book or CD-ROM to estimate maximum I_{CC} .

External Timing Parameters

Over Recommended Operating Conditions

PARAMETER	TEST ⁴ COND.	# ²	DESCRIPTION ¹	-50		UNITS
				MIN.	MAX.	
t _{pd1}	A	1	Data Propagation Delay, 4PT bypass, ORP bypass	-	22.0	ns
t _{pd2}	A	2	Data Propagation Delay	-	26.0	ns
f _{max} (Int.)	A	3	Clock Frequency with Internal Feedback ³	50.3	-	MHz
f _{max} (Ext.)	-	4	Clock Frequency with External Feedback ($\frac{1}{t_{su2} + t_{co1}}$)	34.5	-	MHz
f _{max} (Tog.)	-	5	Clock Frequency, Max Toggle ($\frac{1}{t_{wh} + t_{wl}}$)	58.8	-	MHz
t _{su1}	-	6	GLB Reg. Setup Time before Clock, 4PT bypass	13.0	-	ns
t _{co1}	A	7	GLB Reg. Clock to Output Delay, ORP bypass	-	14.0	ns
t _{h1}	-	8	GLB Reg. Hold Time after Clock, 4 PT bypass	0	-	ns
t _{su2}	-	9	GLB Reg. Setup Time before Clock	15.0	-	ns
t _{co2}	-	10	GLB Reg. Clock to Output Delay	-	16.0	ns
t _{h2}	-	11	GLB Reg. Hold Time after Clock	0	-	ns
t _{r1}	A	12	Ext. Reset Pin to Output Delay	-	20.5	ns
t _{rw1}	-	13	Ext. Reset Pulse Duration	13.5	-	ns
t _{ptoen}	B	14	Input to Output Enable	-	27.5	ns
t _{ptoedis}	C	15	Input to Output Disable	-	27.5	ns
t _{goen}	B	16	Global OE Output Enable	-	20.5	ns
t _{goedis}	C	17	Global OE Output Disable	-	20.5	ns
t _{wh}	-	20	Ext. Sync. Clock Pulse Duration, High	8.5	-	ns
t _{wl}	-	21	Ext. Sync. Clock Pulse Duration, Low	8.5	-	ns
t _{su3}	-	22	I/O Reg. Setup Time before Ext. Sync. Clock (Y2, Y3)	3.0	-	ns
t _{h3}	-	23	I/O Reg. Hold Time after Ext. Sync. Clock (Y2, Y3)	9.0	-	ns

1. Unless noted otherwise, all parameters use a GRP load of 4 GLBs, 20 PTXOR path, ORP and Y0 clock.
2. Refer to Timing Model in this data sheet for further details.
3. Standard 16-Bit counter using GRP feedback.
4. Reference Switching Test Conditions section.

Table 2- 0030-48C/50 mil

Internal Timing Parameters¹

PARAMETER	# ²	DESCRIPTION	-50		UNITS
			MIN.	MAX.	
Inputs					
t _{iobp}	24	I/O Register Bypass	–	4.3	ns
t _{iolat}	25	I/O Latch Delay	–	5.5	ns
t _{iosu}	26	I/O Register Setup Time before Clock	9.1	–	ns
t _{ioh}	27	I/O Register Hold Time after Clock	0.3	–	ns
t _{ioco}	28	I/O Register Clock to Out Delay	–	4.6	ns
t _{ior}	29	I/O Register Reset to Out Delay	–	5.1	ns
t _{din}	30	Dedicated Input Delay	–	7.4	ns
GRP					
t _{grp1}	31	GRP Delay, 1 GLB Load	–	6.2	ns
t _{grp4}	32	GRP Delay, 4 GLB Loads	–	6.7	ns
t _{grp8}	33	GRP Delay, 8 GLB Loads	–	8.0	ns
t _{grp16}	34	GRP Delay, 16 GLB Loads	–	10.5	ns
t _{grp48}	35	GRP Delay, 48 GLB Loads	–	22.7	ns
GLB					
t _{4ptbp}	36	4 Product Term Bypass Path Delay	–	5.5	ns
t _{1ptxor}	37	1 Product Term/XOR Path Delay	–	6.7	ns
t _{20ptxor}	38	20 Product Term/XOR Path Delay	–	7.5	ns
t _{xoradj}	39	XOR Adjacent Path Delay ³	–	8.9	ns
t _{gbp}	40	GLB Register Bypass Delay	–	1.2	ns
t _{gsu}	41	GLB Register Setup Time before Clock	3.9	–	ns
t _{gh}	42	GLB Register Hold Time after Clock	7.3	–	ns
t _{gco}	43	GLB Register Clock to Output Delay	–	2.3	ns
t _{gro}	44	GLB Register Reset to Output Delay	–	2.8	ns
t _{ptre}	45	GLB Product Term Reset to Register Delay	–	11.1	ns
t _{ptoe}	46	GLB Product Term Output Enable to I/O Cell Delay	–	9.6	ns
t _{ptck}	47	GLB Product Term Clock Delay	3.4	8.2	ns
ORP					
t _{orp}	48	ORP Delay	–	3.4	ns
t _{orpbp}	49	ORP Bypass Delay	–	1.4	ns

1. Internal Timing Parameters are not tested and are for reference only.
 2. Refer to Timing Model in this data sheet for further details.
 3. The XOR adjacent path can only be used by hard macros.

Table 2- 0036-48C/50MIL

Internal Timing Parameters¹

PARAMETER	# ²	DESCRIPTION	-50		UNITS
			MIN.	MAX.	
Outputs					
tob	50	Output Buffer Delay	–	2.9	ns
toen	51	I/O Cell OE to Output Enabled	–	6.9	ns
todis	52	I/O Cell OE to Output Disabled	–	6.9	ns
tgoe	53	Global OE	–	13.6	ns
Clocks					
tgy0	54	Clock Delay, Y0 to Global GLB Clock Line (Ref. clock)	7.4	7.4	ns
tgy1/2	55	Clock Delay, Y1 or Y2 to Global GLB Clock Line	6.1	8.7	ns
tgcp	56	Clock Delay, Clock GLB to Global GLB Clock Line	2.6	7.6	ns
tioy2/3	57	Clock Delay, Y2 or Y3 to I/O Cell Global Clock Line	6.1	8.7	ns
tiocp	58	Clock Delay, Clock GLB to I/O Cell Global Clock Line	2.6	7.6	ns
Global Reset					
tgr	59	Global Reset to GLB and I/O Registers	–	11.4	ns

1. Internal Timing Parameters are not tested and are for reference only.
2. Refer to Timing Model in this data sheet for further details.

Table 2- 0037-48C/50mil

DEVICE HAS BEEN PERMANENTLY DISCONTINUED PER PCN#05A-10

ispLSI 1048C/883 Timing Model

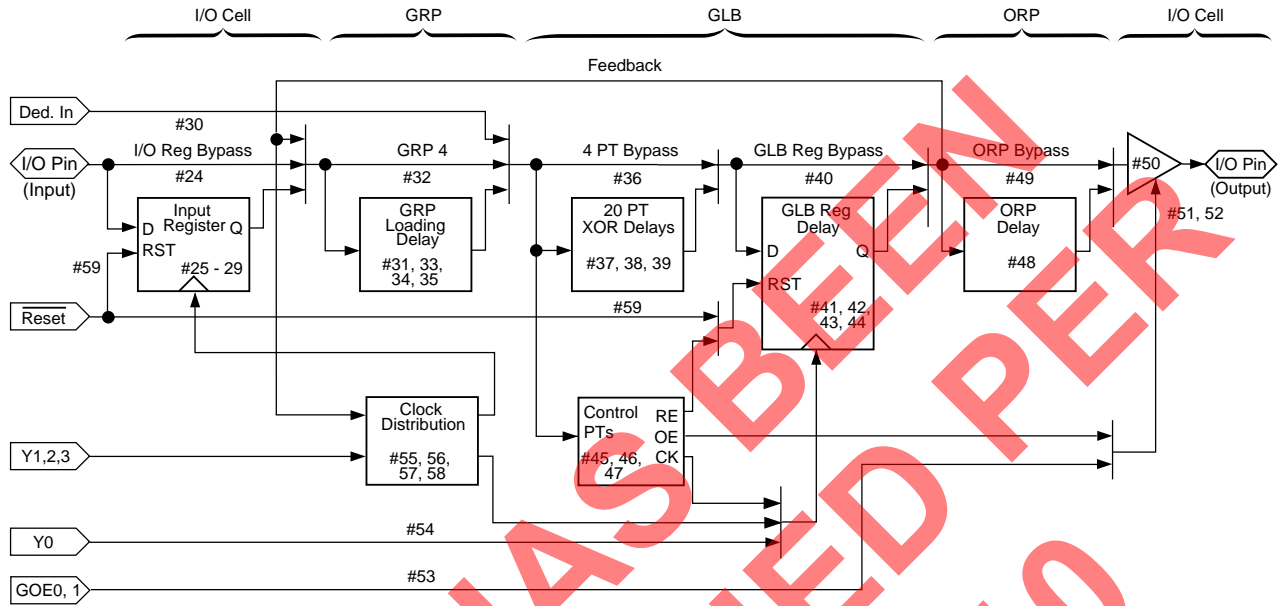

0491A/48

Derivations of tsu, th and tco from the Product Term Clock¹

$$\begin{aligned}
 t_{su} &= \text{Logic} + \text{Reg su} - \text{Clock (min)} \\
 &= (t_{iobp} + t_{grp4} + t_{20ptxor}) + (t_{gsu}) - (t_{iobp} + t_{grp4} + t_{ptck(min)}) \\
 &= (\#24 + \#32 + \#38) + (\#41) - (\#24 + \#32 + \#47) \\
 8.0 \text{ ns} &= (4.3 + 6.7 + 7.5) + (3.9) - (4.3 + 6.7 + 3.4) \\
 \\
 t_h &= \text{Clock (max)} + \text{Reg h} - \text{Logic} \\
 &= (t_{iobp} + t_{grp4} + t_{ptck(max)}) + (t_{gh}) - (t_{iobp} + t_{grp4} + t_{20ptxor}) \\
 &= (\#24 + \#32 + \#47) + (\#42) - (\#24 + \#32 + \#38) \\
 8.0 \text{ ns} &= (4.3 + 6.7 + 8.2) + (7.3) - (4.3 + 6.7 + 7.5) \\
 \\
 t_{co} &= \text{Clock (max)} + \text{Reg co} + \text{Output} \\
 &= (t_{iobp} + t_{grp4} + t_{ptck(max)}) + (t_{gco}) + (t_{orp} + t_{ob}) \\
 &= (\#24 + \#32 + \#47) + (\#43) + (\#48 + \#50) \\
 32.8 \text{ ns} &= (4.3 + 6.7 + 8.2) + (7.3) + (3.4 + 2.9)
 \end{aligned}$$

Derivations of tsu, th and tco from the Clock GLB¹

$$\begin{aligned}
 t_{su} &= \text{Logic} + \text{Reg su} - \text{Clock (min)} \\
 &= (t_{iobp} + t_{grp4} + t_{20ptxor}) + (t_{gsu}) - (t_{gy0(min)} + t_{gco} + t_{gcp(min)}) \\
 &= (\#24 + \#32 + \#38) + (\#41) - (\#54 + \#43 + \#56) \\
 10.1 \text{ ns} &= (4.3 + 6.7 + 7.5) + (3.9) - (7.4 + 2.3 + 2.6) \\
 \\
 t_h &= \text{Clock (max)} + \text{Reg h} - \text{Logic} \\
 &= (t_{gy0(max)} + t_{gco} + t_{gcp(max)}) + (t_{gh}) - (t_{iobp} + t_{grp4} + t_{20ptxor}) \\
 &= (\#54 + \#43 + \#56) + (\#42) - (\#24 + \#32 + \#38) \\
 6.1 \text{ ns} &= (7.4 + 2.3 + 7.6) + (7.3) - (4.3 + 6.7 + 7.5) \\
 \\
 t_{co} &= \text{Clock (max)} + \text{Reg co} + \text{Output} \\
 &= (t_{gy0(max)} + t_{gco} + t_{gcp(max)}) + (t_{gco}) + (t_{orp} + t_{ob}) \\
 &= (\#54 + \#43 + \#56) + (\#43) + (\#48 + \#50) \\
 30.9 \text{ ns} &= (7.4 + 2.3 + 7.6) + (7.3) + (3.4 + 2.9)
 \end{aligned}$$

1. Calculations are based upon timing specifications for the ispLSI 1048C-50

Maximum GRP Delay vs GLB Loads

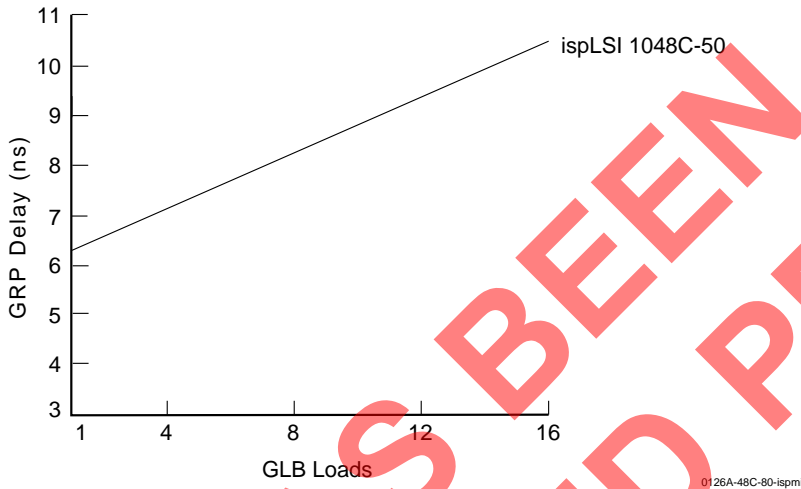

Power Consumption

Power consumption in the ispLSI 1048C/883 device depends on two primary factors: the speed at which the device is operating, and the number of Product Terms used. Figure 3 shows the relationship between power and operating speed.

Figure 3. Typical Device Power Consumption vs fmax

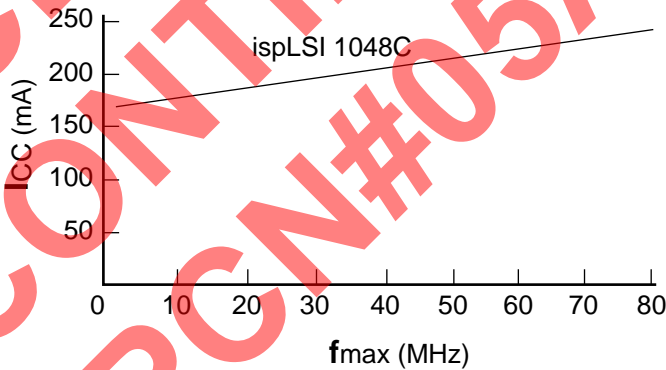

Notes: Configuration of Twelve 16-bit Counters
Typical Current at 5V, 25°C

ICC can be estimated for the ispLSI 1048C using the following equation:

$$I_{CC} = 73 + (\# \text{ of PTs} * 0.23) + (\# \text{ of nets} * \text{Max. freq} * 0.010) \text{ where:}$$

of PTs = Number of Product Terms used in design

of nets = Number of Signals used in device

Max. freq = Highest Clock Frequency to the device

The ICC estimate is based on typical conditions (VCC = 5.0V, room temperature) and an assumption of 2 GLB loads on average exists. These values are for estimates only. Since the value of ICC is sensitive to operating conditions and the program in the device, the actual ICC should be verified.

0127A-48C-80-isp

Pin Description

NAME	CPGA PIN NUMBERS	DESCRIPTION
I/O 0 - I/O 5 I/O 6 - I/O 11 I/O 12 - I/O 17 I/O 18 - I/O 23 I/O 24 - I/O 29 I/O 30 - I/O 35 I/O 36 - I/O 41 I/O 42 - I/O 47 I/O 48 - I/O 53 I/O 54 - I/O 59 I/O 60 - I/O 65 I/O 66 - I/O 71 I/O 72 - I/O 77 I/O 78 - I/O 83 I/O 84 - I/O 89 I/O 90 - I/O 95	J2, J3, K1, L1, K2, M1, L2, K3, N1, M2, L3, P1, M3, P2, N3, M4, P3, N4, P4, M5, N5, P5, M6, N6, N9, M9, P10, P11, N10, P12, N11, M10, P13, N12, M11, P14, M12, N14, M13, L12, M14, L13, L14, K12, K13, K14, J12, J13, F13, F12, E14, D14, E13, C14, D13, E12, B14, C13, D12, A14, C12, A13, B12, C11, A12, B11, A11, C10, B10, A10, C9, B9, B6, C6, A5, A4, B5, A3, B4, C5, A2, B3, C4, A1, C3, B1, C2, D3, C1, D2, D1, E3, E2, E1, F3, F2	Input/Output Pins - These are the general purpose I/O pins used by the logic array.
GOE0, GOE1	N13, B7,	Global output enables for all I/Os.
IN 2, IN 4 IN 6 - IN 11	P7, P9 F14, A9, A8, A7, A6, F1	Dedicated input pins to the device.
$\overline{\text{ispEN}}$	H2	Input - Dedicated in-system programming enable input pin. This pin is brought low to enable the programming mode. The MODE, SDI, SDO and SCLK options become active.
SDI/IN 0 ¹	J1	Input - This pin performs two functions. It is a dedicated input pin when $\overline{\text{ispEN}}$ is logic high. When $\overline{\text{ispEN}}$ is logic low, it functions as an input pin to load programming data into the device. SDI/IN 0 also is used as one of the two control pins for the isp state machine.
MODE/IN 1 ¹	P6	Input - This pin performs two functions. It is a dedicated input pin when $\overline{\text{ispEN}}$ is logic high. When $\overline{\text{ispEN}}$ is logic low, it functions as a pin to control the operation of the isp state machine.
SDO/IN 3 ¹	P8	Input/Output - This pin performs two functions. It is a dedicated input pin when $\overline{\text{ispEN}}$ is logic high. When $\overline{\text{ispEN}}$ is logic low, it functions as an output pin to read serial shift register data.
SCLK/IN 5 ¹	J14	Input - This pin performs two functions. It is a dedicated input when $\overline{\text{ispEN}}$ is logic high. When $\overline{\text{ispEN}}$ is logic low, it functions as a clock pin for the Serial Shift Register.
RESET	H1	Active Low (0) Reset pin which resets all of the GLB and I/O registers in the device.
Y0	G1	Dedicated Clock input. This clock input is connected to one of the clock inputs of all of the GLBs on the device.
Y1	G14	Dedicated clock input. This clock input is brought into the clock distribution network, and can optionally be routed to any GLB on the device.
Y2	H13	Dedicated clock input. This clock input is brought into the clock distribution network, and can optionally be routed to any GLB and/or any I/O cell on the device.
Y3	H14	Dedicated clock input. This clock input is brought into the clock distribution network, and can optionally be routed to any I/O cell on the device.
GND	B2, B8, B13, C8, H3, H12, M8, N2, N8	Ground (GND)
VCC	C7, G2, G3, G12, G13, M7, N7	V _{cc}

1. Pins have dual function capability.

Table 2- 0002C-48C/CPGA

Pin Configuration

ispLSI 1048C/883 133-Pin CPGA Pinout Diagram



1. Pins have dual function capability.

133 CPGA Pinout.eps

Part Number Description

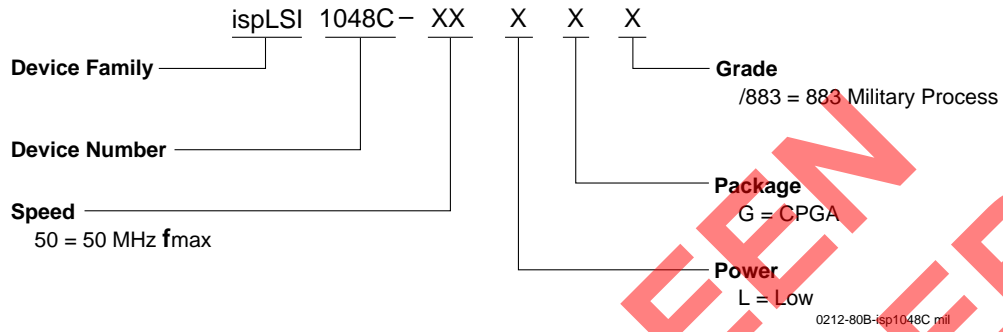

Ordering Information

MILITARY

Family	f_{max} (MHz)	t_{pd} (ns)	Ordering Number	SMD Number	Package
ispLSI	50	22	ispLSI 1048C-50LG/883	5962-9558701MXC	133-Pin CPGA

Table 2- 0041A-48C-ispmil

DEVICE HAS BEEN PER
 DISCONTINUED
 PCN#05A-10